

EXTERNAL AREA CERAMIC & CONTAINER CHASSIS CONNECTION DETAIL

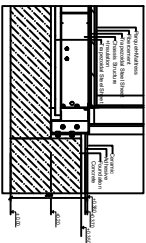

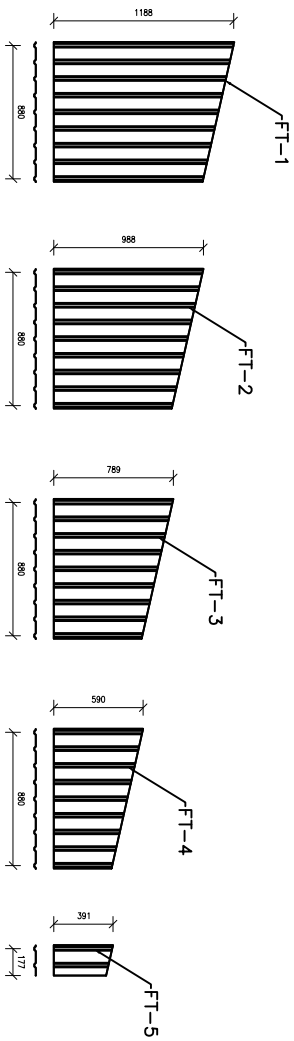
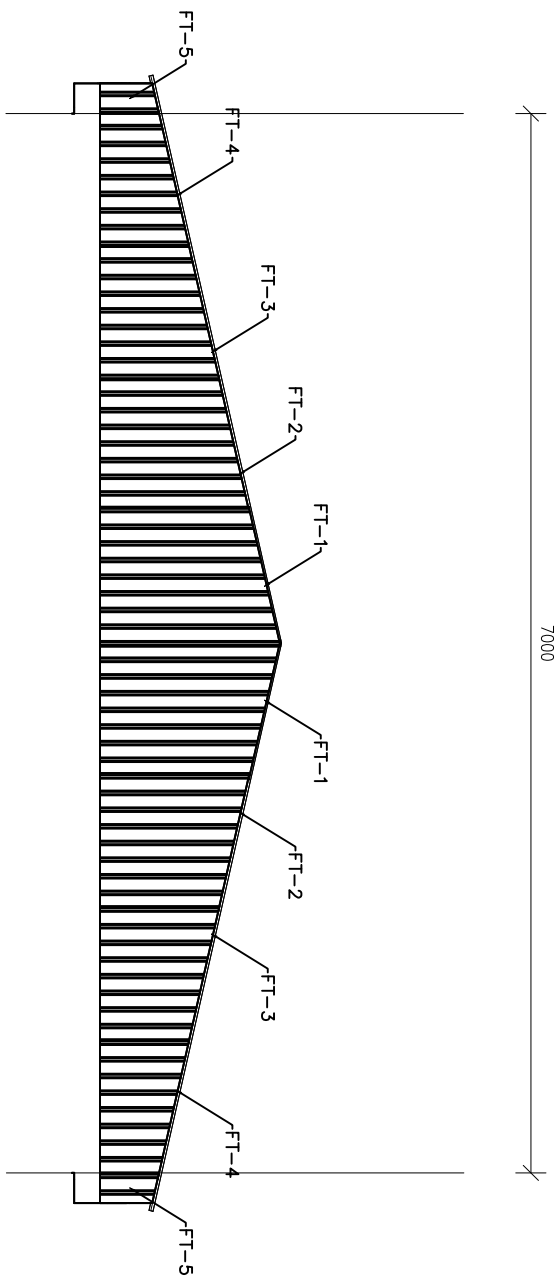

110/923 TRAPEZOIDAL SHEET
Thickness : 0,6 mm (ral9002)
(Useful width: 880 mm)

110/923 TRAPEZOIDAL SHEET					
NO:	TH(mm)	Color	Useful Width (mm)	Length(mm)	Qty.
FT-1	0,6	RAL 9002	880	1188	4
FT-2	0,6	RAL 9002	880	988	4
FT-3	0,6	RAL 9002	880	790	4
FT-4	0,6	RAL 9002	880	590	4
FT-5	0,6	RAL 9002	177	391	4

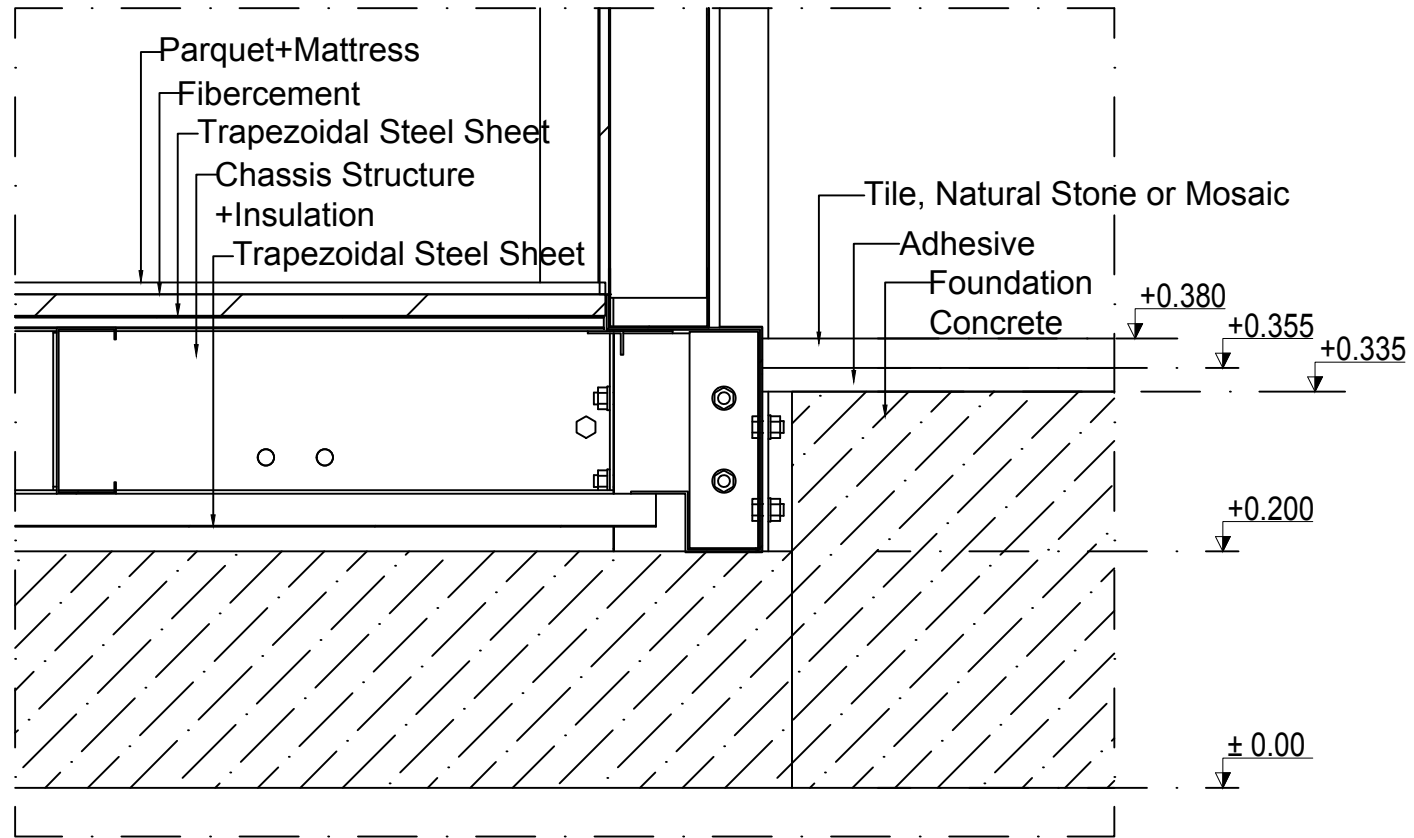

EXTERNAL AREA TILE, NATURAL STONE OR MOSAIC
 CONTAINER CHASSIS CONNECTION DETAIL

5
 MODEL

SCALE:1/16

FENCE (STEEL MESH)

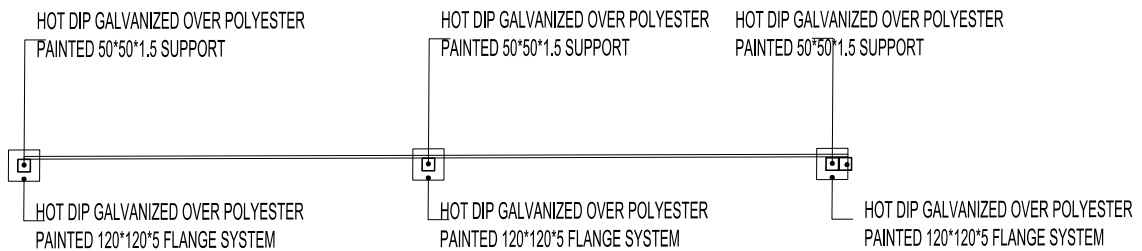
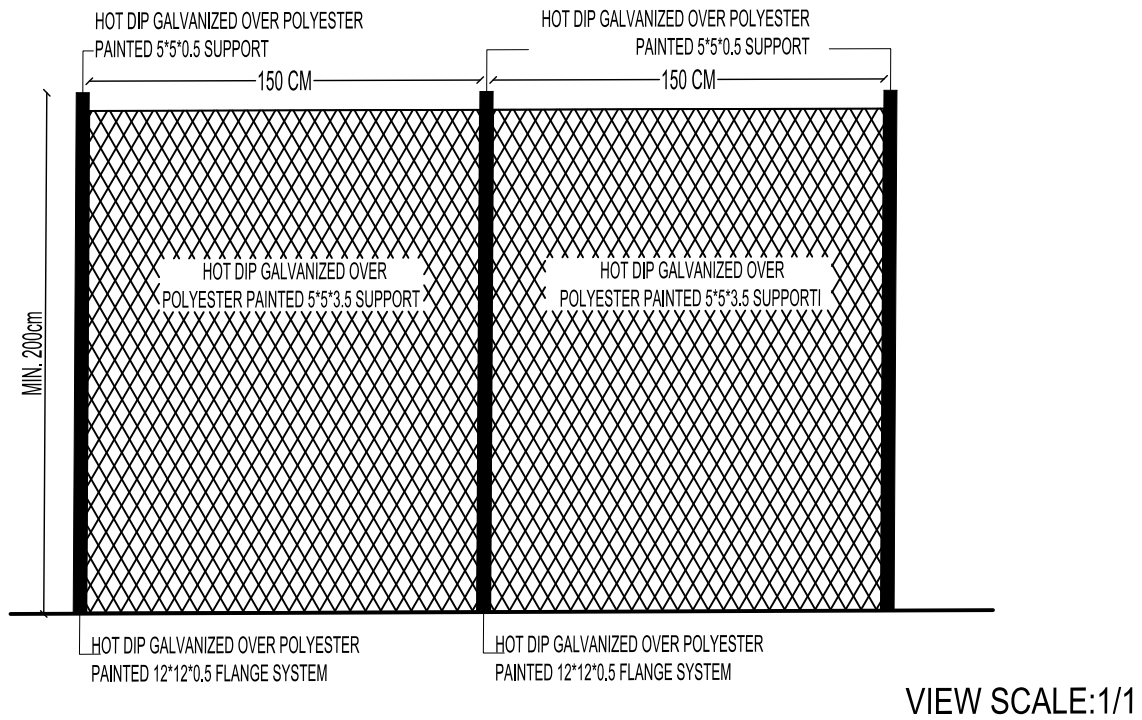

NOTES:

- BEFORE STARTING MANUFACTURING, ALL MEASUREMENTS WILL BE CHECKED ON-SITE AND MANUFACTURING MEASUREMENTS WILL BE TAKEN.

FENCE STEEL SHEET DETAIL (19.2)

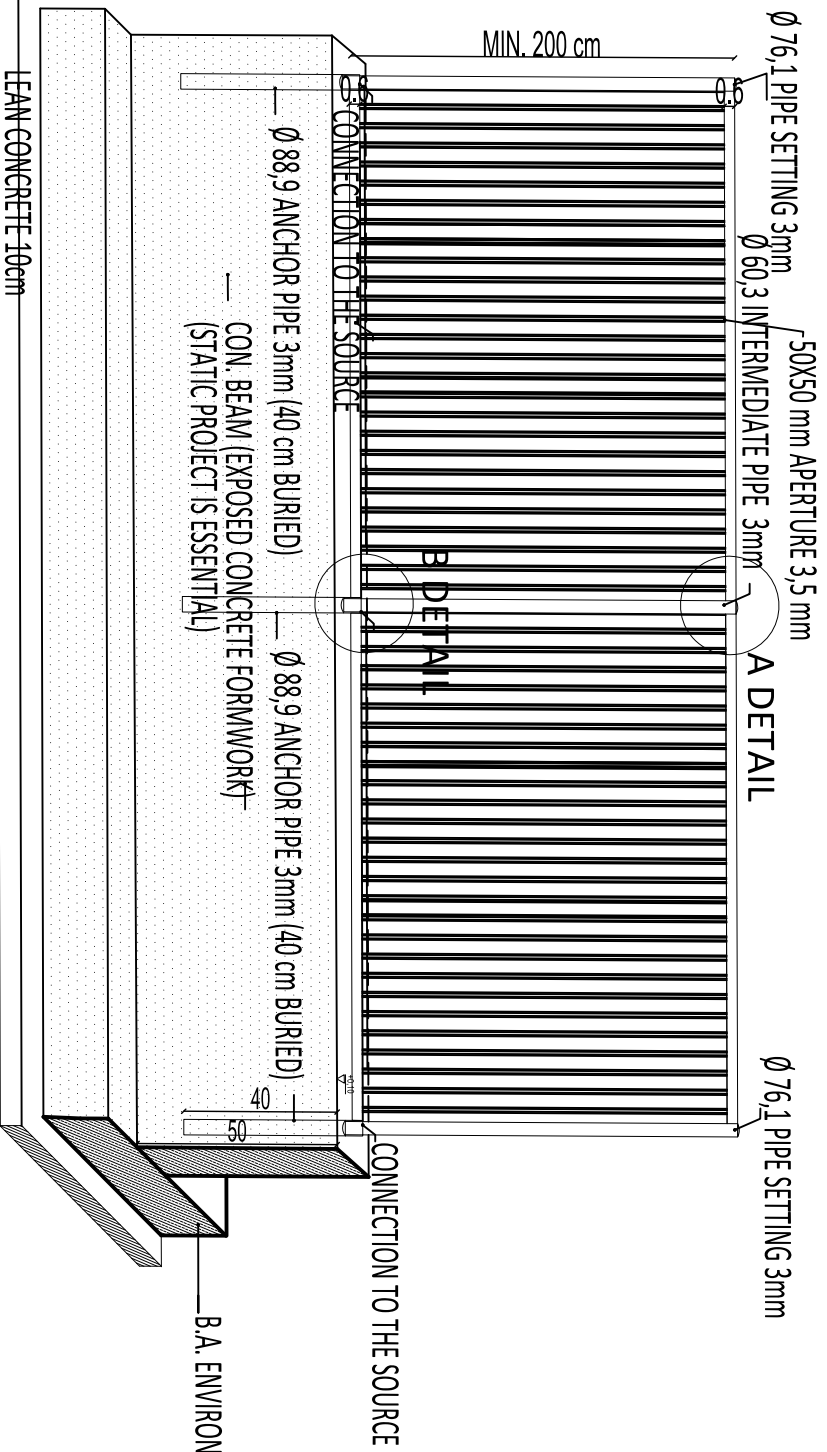

B.A. ENVIRONMENTAL RAIL (EXPOSED CONCRETE FORMWORK)

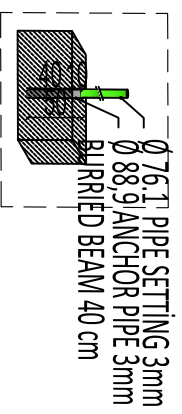

GALVANIZED FENCE CONNECTION DETAILS



A DETAIL SCALE:1/5

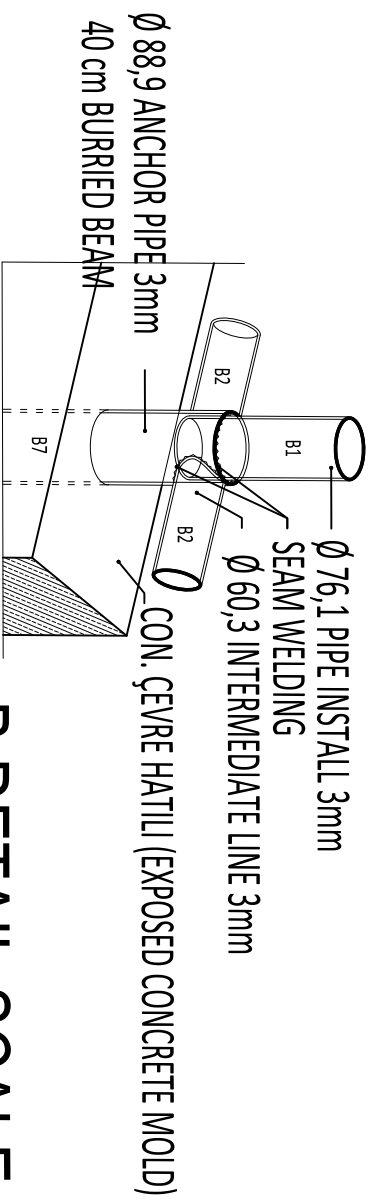

B DETAIL SCALE:1/5

SHADE STEEL STRUCTURE

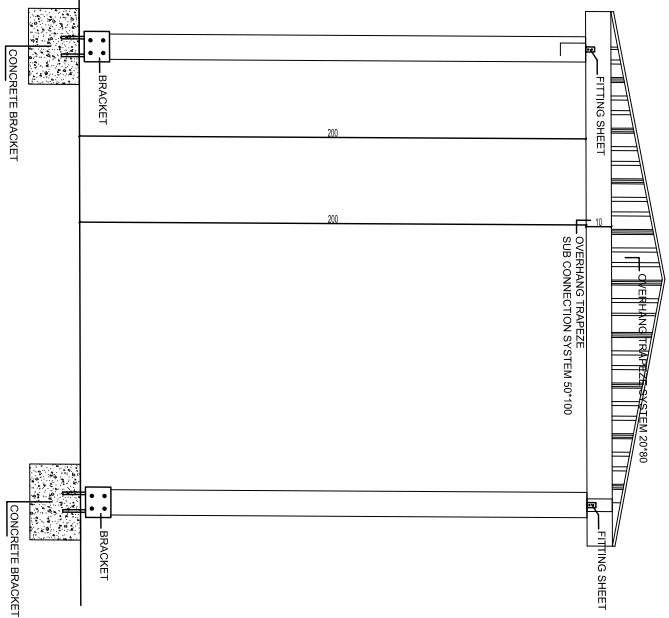
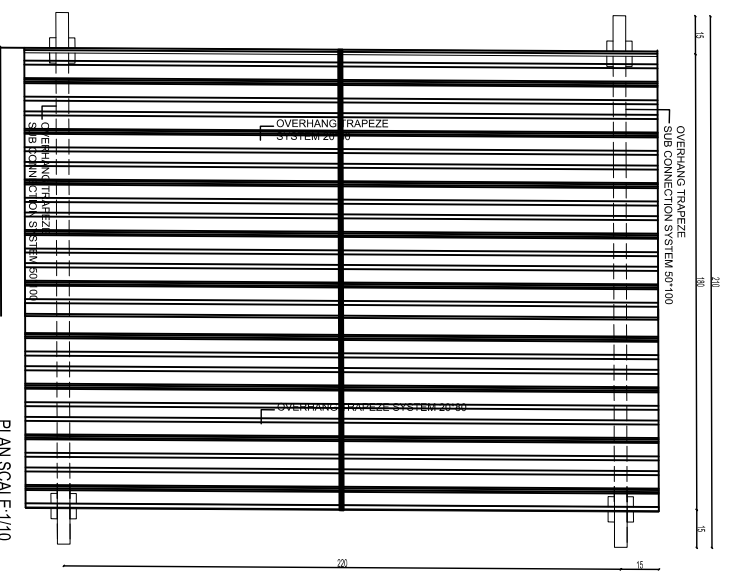

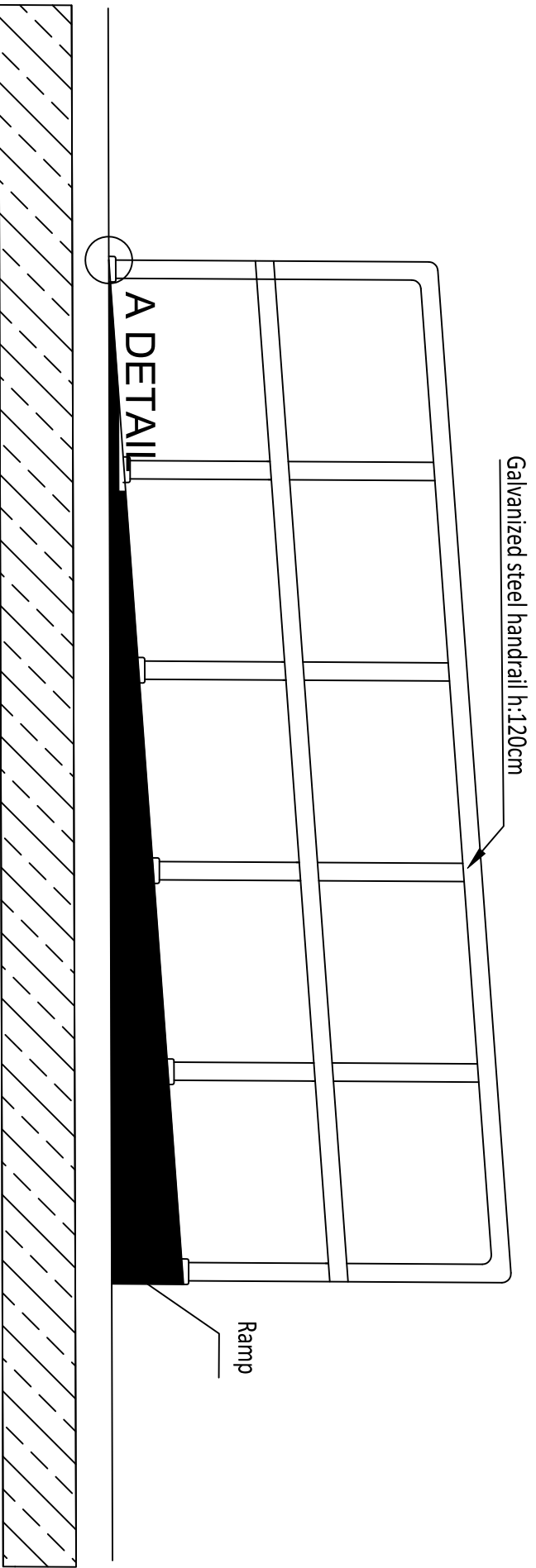

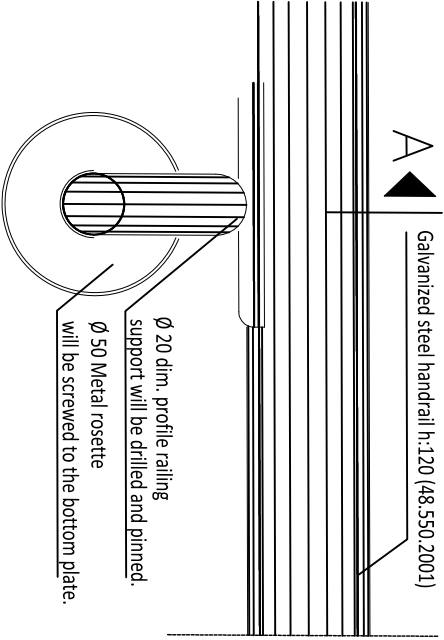

ASPECT

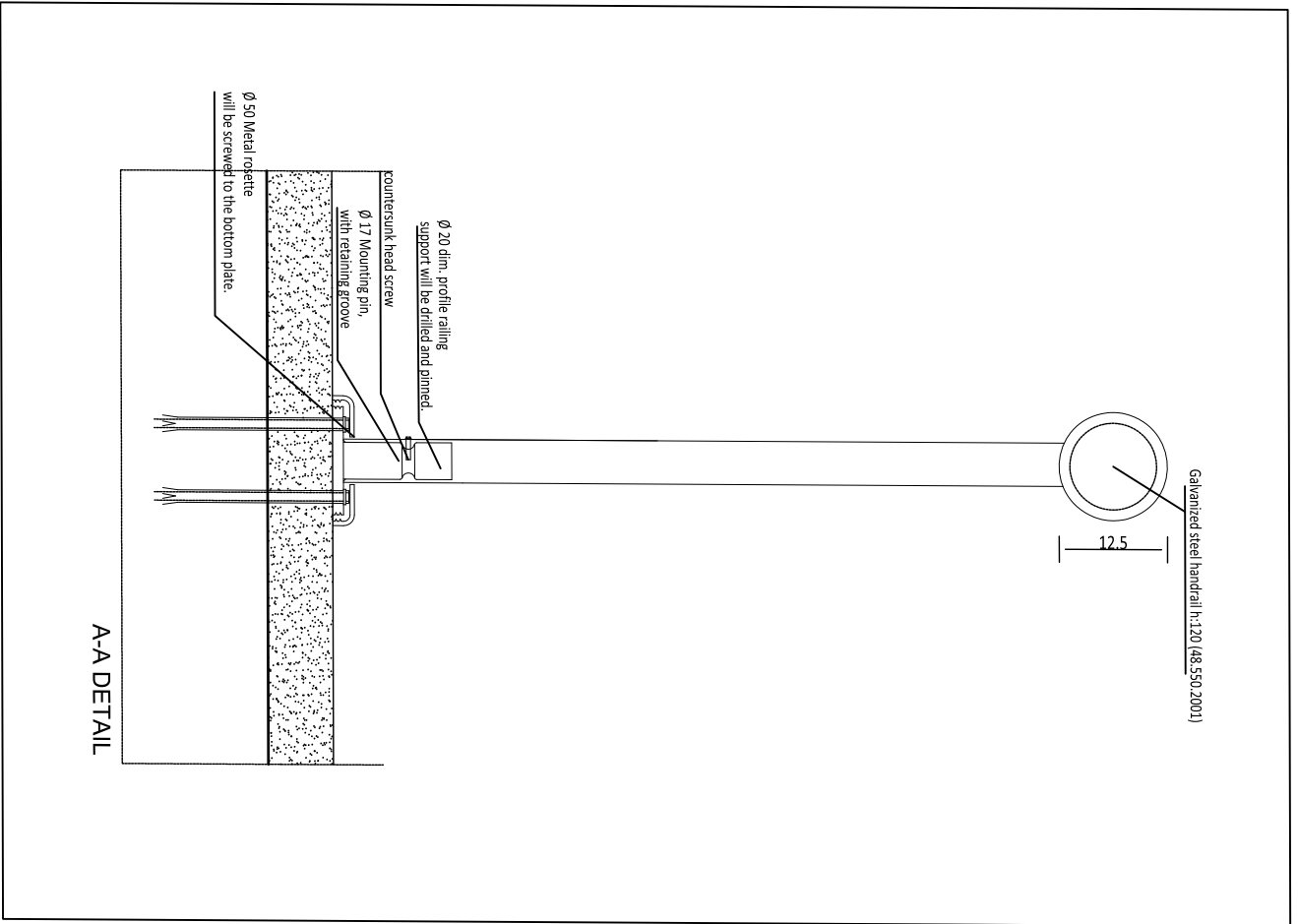

W2 600x400

EF 300m³/h

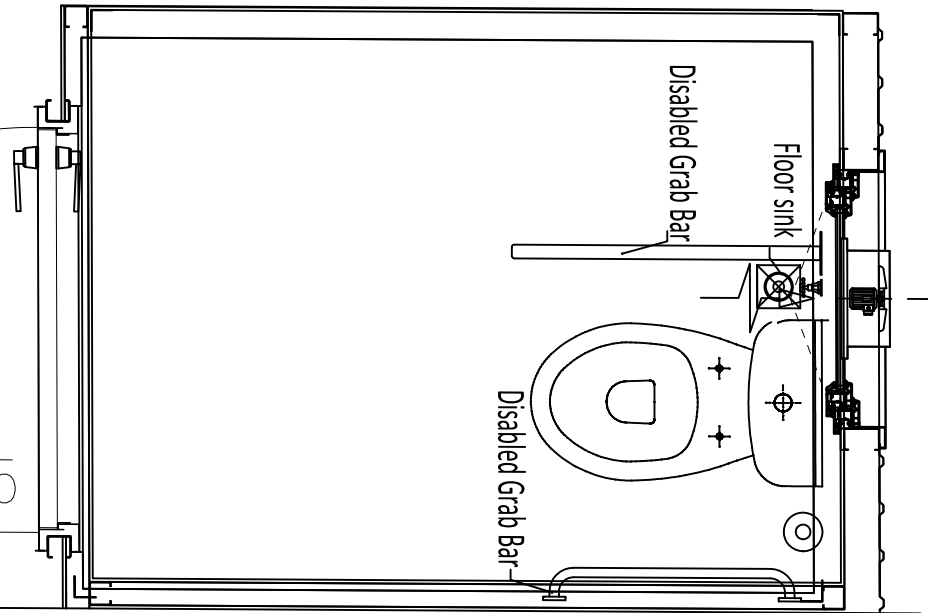

Disabled Grab Bar

FLOOR SINK

Disabled Grab Bar

D3R 964x2015